

Muller II



S.L	ORIGINAL CODE	DESCRIPTION	S.L	ORIGINAL CODE	DESCRIPTION
L00		GRIPPER	R00	44359T48	GRIPPER
L01		GRIPPER BODY	R01	43372T231	GRIPPER BODY
L02	641372	SPRING	R02	43372T231	THREAD GUIDE
L03	641041	THREAD GUIDE	R03	43358T64	HOOK
L04		PLATE	R04	40380T57	LEVER
L05		NYLON BUSH	R05	5945T240	SIDE PLATE
L06		SPRING FIXED BLOCK	R06	641971	SPRING
L07		SPRING FIXED BLOCK	R07	5956T246	SCREW CAP
L08		SCREW	R08	5946T242	LEVER SHAFT
L09		SCREW	R09		BUSH
L10		SCREW	R10		SPRING HOLDER
L11		SCREW	R11		SCREW
L12		SCREW	R12		SCREW
L13		SCREW	R13		SCREW
			R14		SCREW

Muller III



S.L	ORIGINAL CODE	DESCRIPTION	S.L	ORIGINAL CODE	DESCRIPTION
L00		ENTER GRIPPER	R00		EXIT GRIPPER
L01		GRIPPER BODY	R01	621327	GRIPPER BODY
L02	642763	SPRING	R02	621264	
L03		THREAD GUIDE	R03	642350	CLAMPING SPRING
L04		PLATE	R04	621402	HOOK
L05		NYLON BUSH	R05	631712	LEVER
L06		SPRING FIXED BLOCK "A"	R06		OPENING LEVER
L07		SPRING FIXED BLOCK "B"	R07		SLIDER
L08			R08		BODY III
L09			R09		
L10			R10		
L11			R11		
L12			R12		
L13			R13		

Muller IV

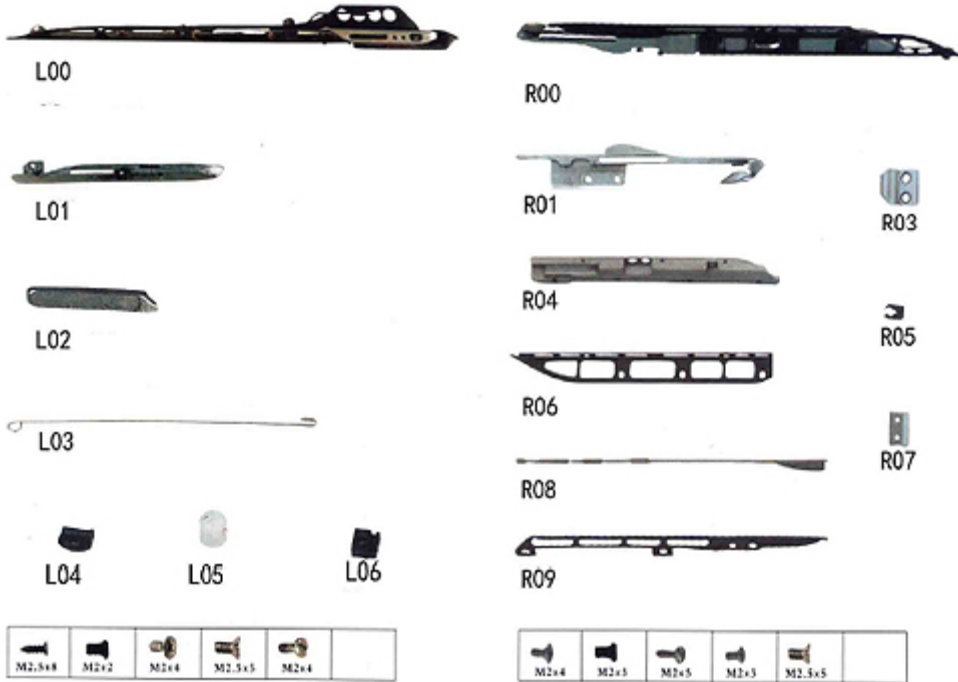

S.L	ORIGINAL CODE	DESCRIPTION	S.L	ORIGINAL CODE	DESCRIPTION
L00		ENTER GRIPPER	R00	R00	EXIT GRIPPER
L01		THREAD GUIDE	R01	621327	HOOK
L02		PLATE	R02	621264	OPENING LEVER
L03		SPRING	R03	642350	BODY I
L04		PLATE	R04	621402	PRESSURE BLOCK
L05		NYLON BUSH	R05	631712	GRIPPER BODY II
L06		PROTECTIVE BLOCK	R06		PRESSURE BLOCK
L07			R07		LEVER
L08			R08		BODY III
L09			R09		
L10			R10		
L11			R11		
L12			R12		
L13			R13		

Rapier Tapes Muller

┌



ORIGINAL CODE: 621216 TAPE MULLER II L = 952 LH



ORIGINAL CODE: 621192 TAPE MULLER II L=948 RH



ORIGINAL CODE: 621571/671224 TAPE MULLER III LH L=1091 mm



ORIGINAL CODE: 621572/671226 TAPE MULLER III RH L=1077 mm



ORIGINAL CODE: 621571 TAPE MULLER 3. 1 L =1091 LH



ORIGINAL CODE: 621675 TAPE MULLER 3.1 L=1077 RH



ORIGINAL CODE: 621216C TAPE MULLER I L=952 LH



ORIGINAL CODE: 621192C TAPE MULLER I L=940 RH

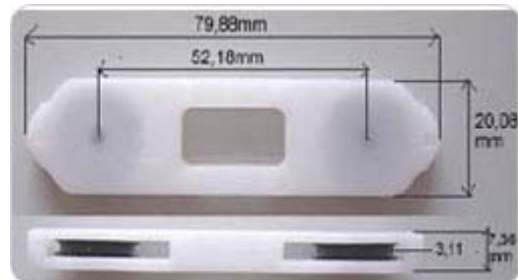

P1: PULLEY MULLER MJ2 BIG

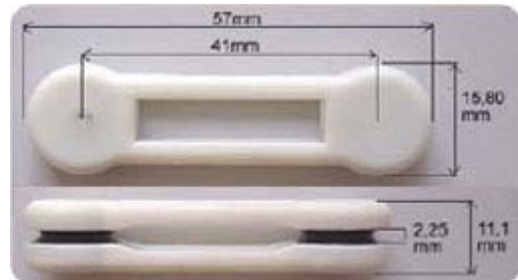

P2: LITTLE PULLEY MULLER MJ2

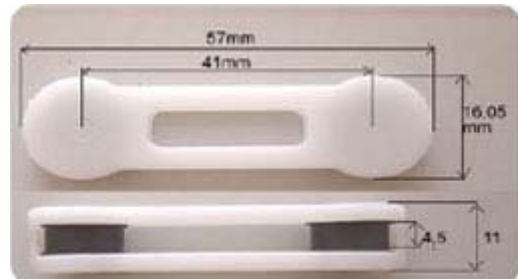

P3: PULLEY MULLER MJ2 57x11mm

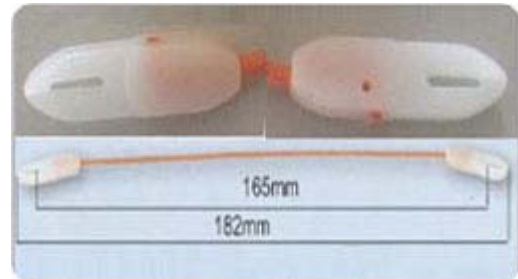

P4: 335-406, JACQUARD ROPE 181mm MULLER/BONAS

Jacquard Ropes And Hooks



JACQUARD ROPE L=225mm



JACQUARD ROPE L= 278mm



JACQUARD ROPE L= 310
mm



PR SHAH PVT LTD
PR SHAH PVT LTD

JACQUARD ROPE L= 370 mm



JACQUARD ROPE L= 310 mm



JACQUARD ROPE L= 435 mm



JACQUARD ROPE L= 223 mm



325-306, JACQUARD ROPE L=216mm

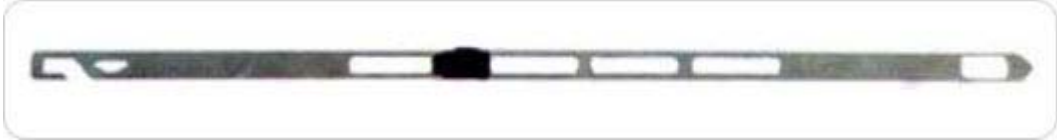

JACQUARD HOOK L = 290 MM



JACQUARD HOOK L = 355 MM



JACQUARD HOOK L = 310MM



JACQUARD HOOK L = 360 MM



JACQUARD HOOK L = 390MM



JACQUARD HOOK L = 490MM

PR SHAH PVT LTD
PR SHAH PVT LTD

Openers And Cutters



53501259, MULLER OPENER FOR MULLER 3



641825, MUGRIP OPENER FOR MULLER 2



641662, MUGRIP OPENER



179631846, MUGRIP OPENER



631725, MOBILE BLADE FOR WEFT MULLER 2



631629, BLADE FOR WEFT MULLER 2



631845, BLADE FOR WEFT MULLER 3



631846, MOBILE BLADE FOR WEFT MULLER 3

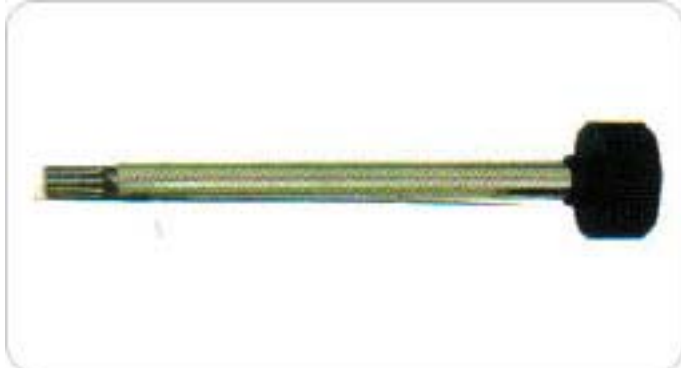

1074-10, DEVICE TO REGULATE CUTTERS DIAM.10

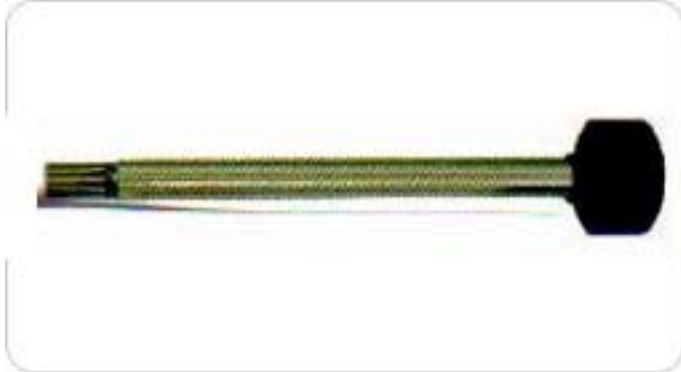

1073-6, DEVICE TO REGULATE CUTTERS DIAM.6

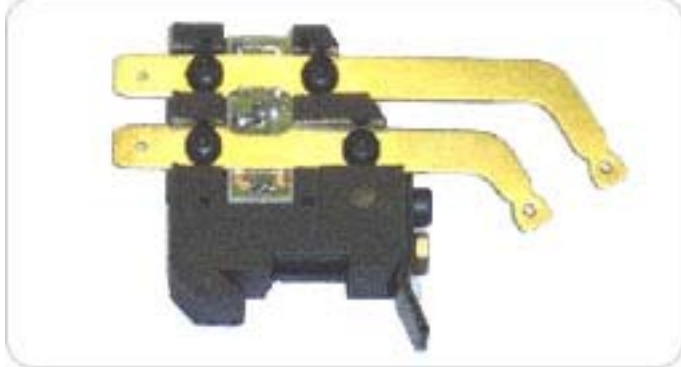

51404028, SINGLE THERMAL CUTTER MULLER MOD.2

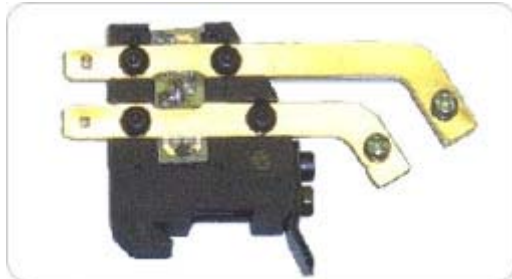

632720, DOUBLE THERMAL CUTTER MULLER MOD.3



SINGLE THERMAL CUTTER MUJET S01



SINGLE THERMAL CUTTER S02 NEW



SINGLE THERMAL CUTTER S03



THERMIC BLADE WITH CABLE MULLER S04



THERMIC BLADE WITH CABLE L01



THERMIC BLADE WITH CABLE L02



THERMIC BLADE WITH CABLE L03



THERMIC BLADE WITH CABLE L04



THERMIC BLADE WITH CABLE L05



GUIDE HOOK MULLER MOD.2



GUIDE HOOK MULLER MOD.3/1



GUIDE HOOK MULLER MOD.3/2



MULLER SUPER CUTTER MUSONIC 2



MULLER SUPER CUTTER MUSONIC 3



MULLER SUPER CUTTER MUSONIC 4



STAUBILI BLOCK



CONNECTION LINE 01



CONNECTION LINE 02

Jacquard Pulley



JP-01



JP-02



JP-03

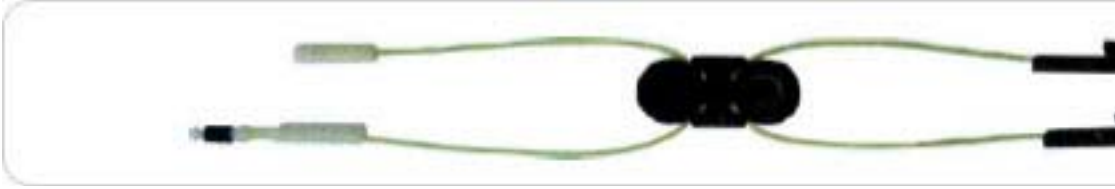

JP-04

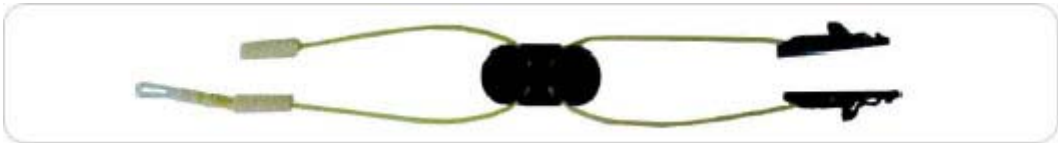

JP-05



JP-06



JP-07



JP-08



JP-09

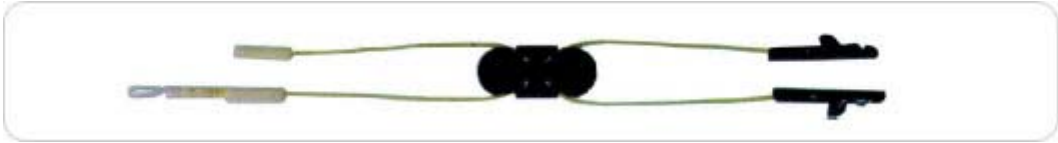

JP-10



JP-11



JP-12

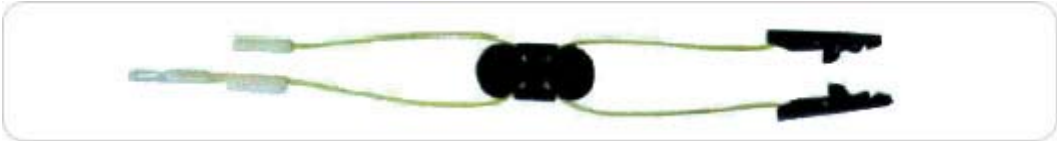

JP-13

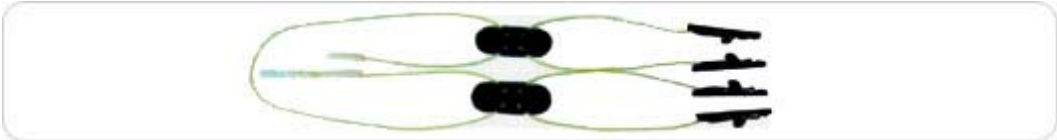

JP-14



JOINT HEAD



335595, JACQUARD PULLING MULLER MUGRIP



TAU-2688-M4: CX-960



2688-M5: LX1600



CX990



CX860

Electromagnet Valves



MAGNET X JACQUARD J29164103



PARTITION STRIP



335592, MAGNET JACQUARD MGRIP 3 BLEU, J5339 315339



Electronic Board COMPLETE NO 3



ELECTRONIC BOARD COMPLETE NO 1 (without magnets)



ELECTRONIC BOARD COMPLETE NO 2 (without magnets)



MAGNET BARS USED IN ALL KINDS OF ELECTRIC DOBBY MACHINE



MAGNET BARS USED IN ALL KINDS OF ELECTRIC DOBBY MACHINE

MACHINE

Needles For Needle Looms



NE001



NE002

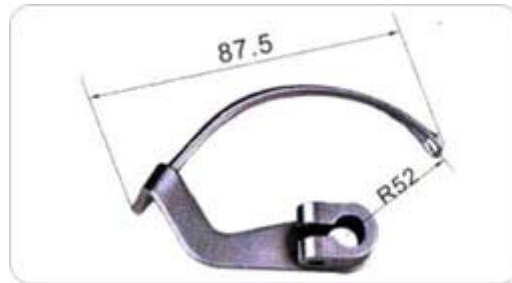

NE003

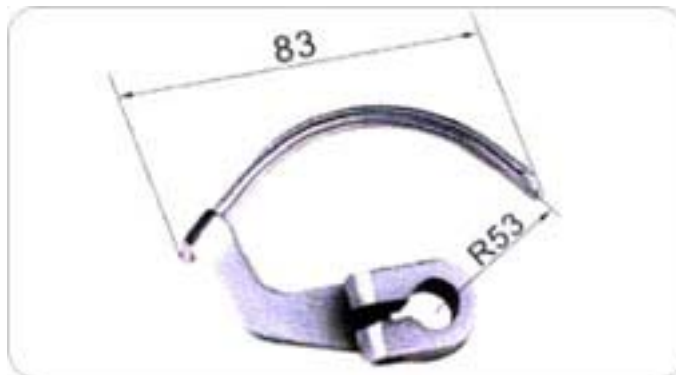

NE004

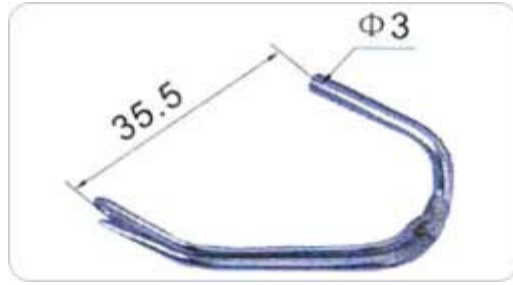

NE005

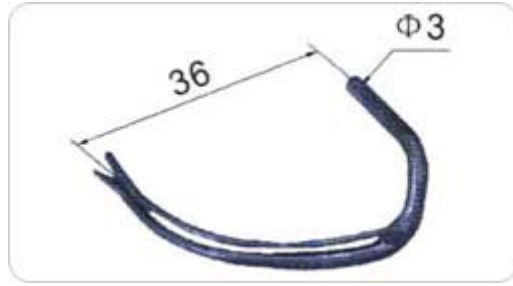

NE006

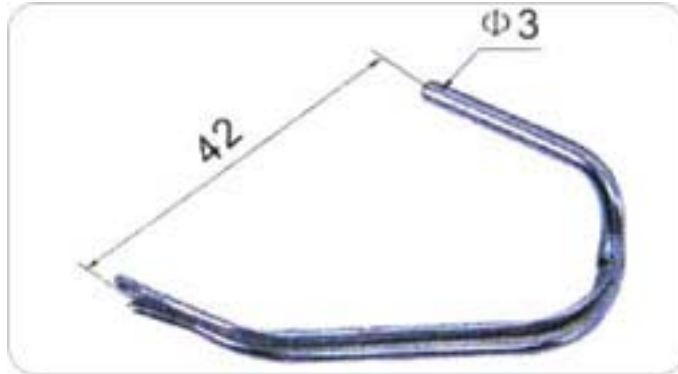

NE007

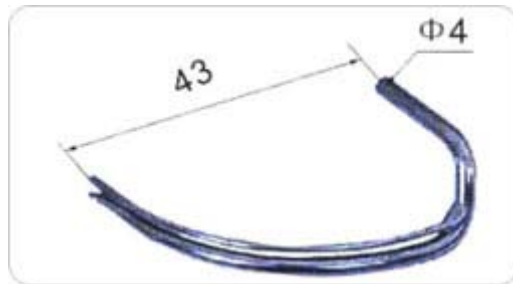

NE008

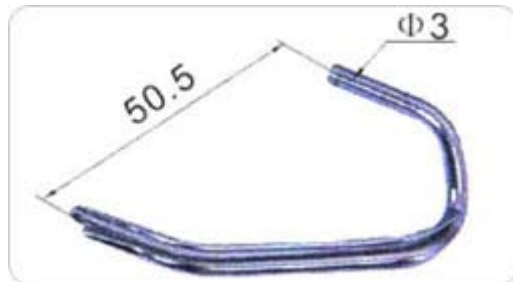

NE009



NE010



NE011

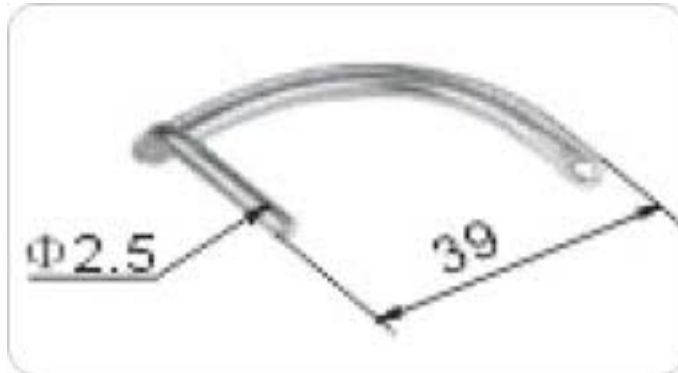

NE012



NE013

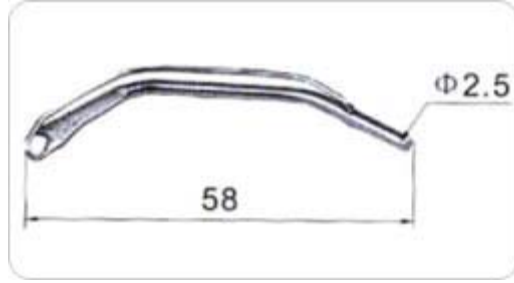

NE014

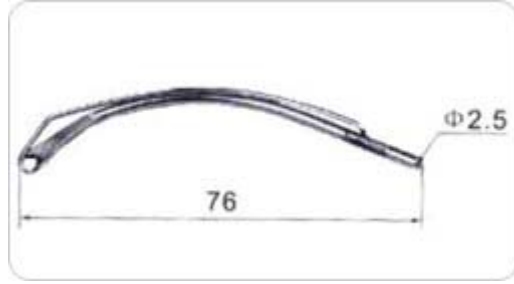

NE015

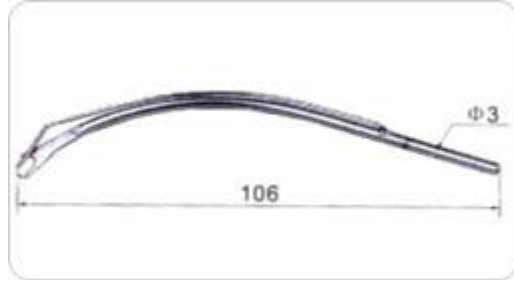

NE016

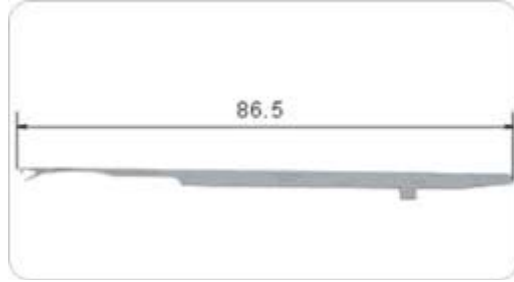

NE017

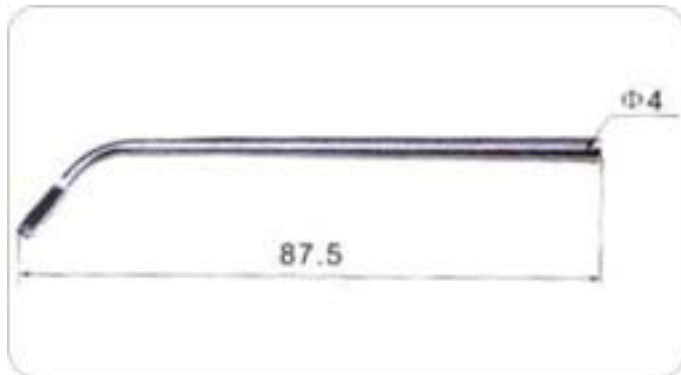

NE018

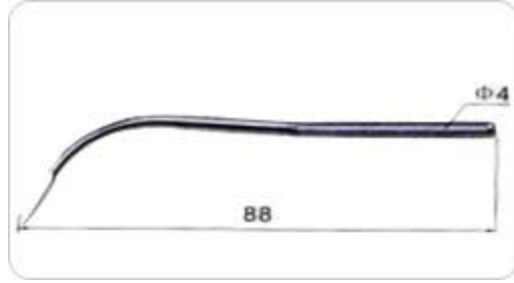

NE019

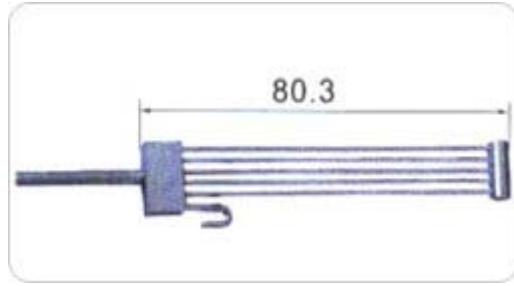

NE020

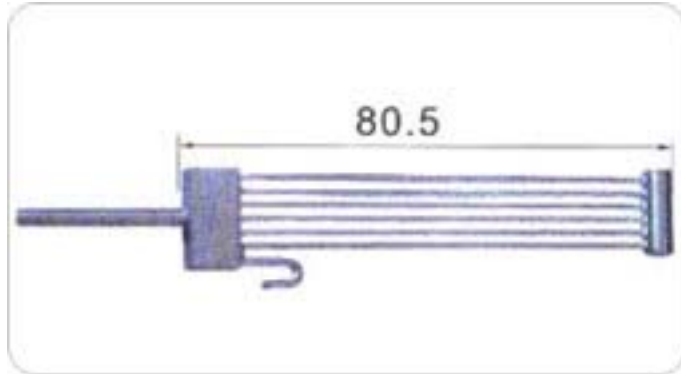

NE021

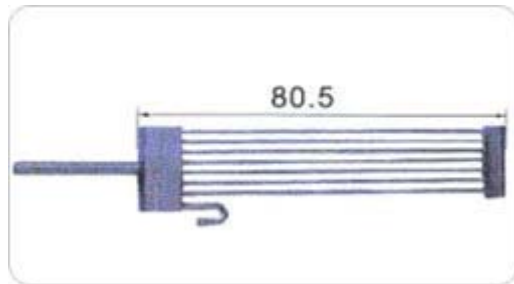

NE022